

GRU A TORRE

GA 301

GRU AUTOMATICA CON
MONTAGGIO IDRAULICO

GA compact



GX



GHS topless



0 - 4000 kg



TII

FBGRU
LIFT YOUR GOALS!

FB F.lli Butti s.r.l.

Via XXV Aprile, 58

23868 Valmadrera (LC) - Italia

Tel. 0341.581108 - Fax 0341.200253

E-mail : fbgru@fbgru.it - <http://www.fbgru.it>

CE

FEM 1.001 - A3
EN 14439 - C25

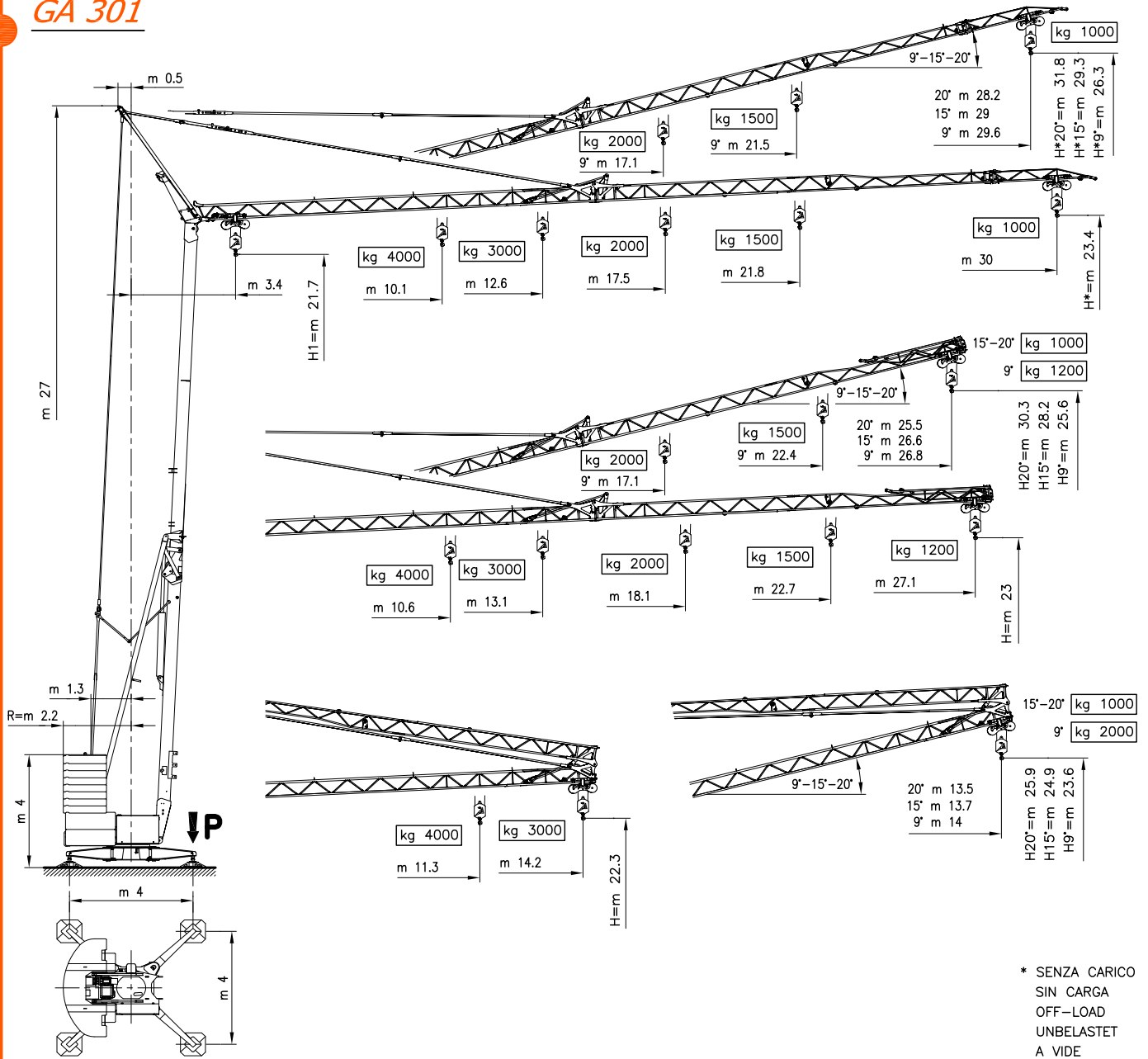

* SENZA CARICO
SIN CARGA
OFF-LOAD
UNBELASTET
A VIDE

P	
kg 22150 <i>In servizio</i> En servicio In service In betrieb En service	kg 14450 <i>Fuori servizio</i> Fuera de servicio Out of service Außer betrieb Hors service

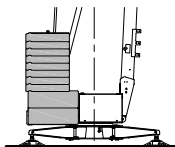
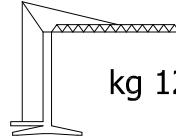
	
 N° 8x1800 N° 2x1700 N° 2x1920 kg 33770	 kg 12130

LA GRU LA GRÚA — CRANE
KРАН — GRUE



MOVIMENTO MOVIMIENTO MOVEMENT BEWEGUNG MOUVEMENT	ALIMENTAZIONE ALIMENTACION OPERATING VOLTAGE BETRIEBSSPANNUNG TENSION DE SERVICE	PRESTAZIONI FUNCIONAMIENTOS PERFORMANCES LEISTUNGEN EXÉCUTIONS	
---	---	---	--

SOLLEVAMENTO ELEVACION — HOISTING HEBEN — LEVAGE INVERTER	400 V 50 Hz		1 ^a m/1' - kg	2 ^a m/1' - kg	3 ^a m/1' - kg	4 ^a m/1' - kg	kW 15
			4	20	35	50	
			4000	4000	2000	1400	

CARRELLO CARRILLO — JIB TROLLEY LAUFKATZE — DISTRIBUTION INVERTER	400 V 50 Hz		1 ^a m/1'	2 ^a m/1'	3 ^a m/1'	kW 3
			19	45	61	

ROTAZIONE ROTACION — SLEWING DREHEN — ORIENTATION INVERTER	400 V 50 Hz		1 ^a g/1'	2 ^a g/1'	3 ^a g/1'	kgm 2.5
			0 → 0.14	0.14 → 0.45	0.45 → 0.93	



Conforme alle direttive
CEE sul livello acustico
2000/14/CE

Conforme con las directivas
CEE sobre el nivel acustico

In compliance with the EEC
instructions on noise level

Gemass EWG-Richtlinien für
den Schall-Leistungspegel

Conforme aux directives CEE
sur le niveau acoustique

CURVE DI CARICO

CURVAS DE CARGAS — LOAD DIAGRAMS

LASTKURVEN — COURBES DE CHARGES

V30

	m	3.4	5	8	10.1	11	12	12.6	14	15	17.5	18	20	21.8	22	24	26	28	30
	kg	4000				3590	3203	3000	2626	2405	2000	1910	1673	1500	1484	1330	1201	1093	1000

	m	3.4	5	8	10	12	14	16	17.1	18	19	20	21	21.5	22	24	26	28	29.6
	kg	2000								1882	1759	1649	1550	1500	1462	1310	1183	1076	1000

	m	3.4	5	10	15	20	25	29
	kg	1000						

	m	3.4	5	10	15	20	25	28.2
	kg	1000						

(0 - 4000 kg)

POTENZA RICHIESTA

POTENCIA-ELECTRICA NECESARIA — NECESSARY ELECTRIC POWER

KRAFTBEDARF — PUISSANCE ELECTRIQUE NECESSAIRE

	SOLLEVAMENTO ELEVACION — HOISTING — HEBEN — LEVAGE	kg 4000
	14 kw 400 V - 50 Hz	

TRASPORTO TRANSPORTE — TRANSPORT
TRANSPORT — TRANSPORT

5
km/h

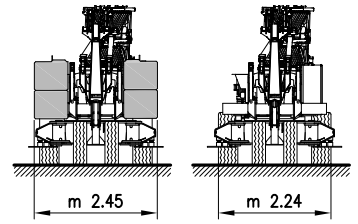
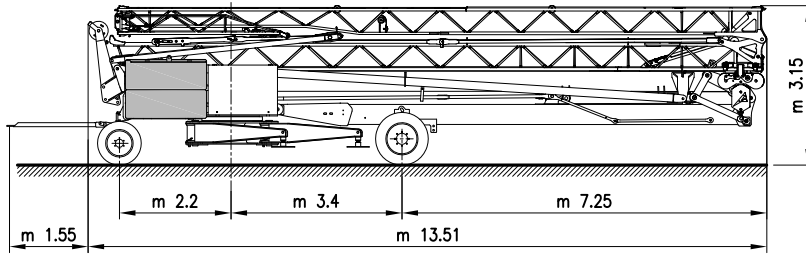

FB25K1

25
km/h

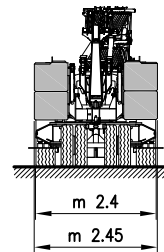
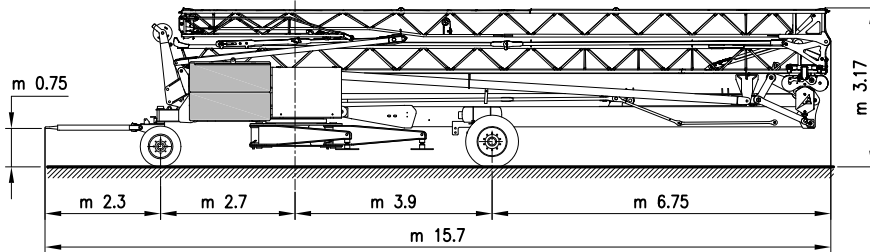

MONTAGGIO MONTAJE — ERECTION
MONTAGE — MONTAGE

